

Trans-oceanic class ultra-long-haul transmission using multi-core fiber

Itsuro Morita,^{1,*} Koji Igarashi,^{1,2} Hidenori Takahashi,³ Takehiro Tsuritani,¹ and Masatoshi Suzuki¹

¹KDDI R&D Laboratories Inc., 2-1-15 Ohara Fujimino, Saitama 356-8502, Japan

²Division of Electrical, Electronic and Information Engineering, Osaka University, 2-1 Yamadaoka, Suita, Osaka 565-0871, Japan

³KDDI Corporation, 3-10-10, Iidabashi, Chiyoda-ku, Tokyo, 102-8460 Japan

*morita@kddilabs.jp

Abstract: Space-division multiplexing with uncoupled multi-core fiber is a promising technology to drastically increase a fiber capacity in optical communication systems. Trans-oceanic class ultra-long-haul transmission was successfully achieved by using 7-core MCF with suppressed inter-core crosstalk. By using a combination of MCF and spectral efficient modulation format, the fiber capacity could be increased from 28.8 Tbit/s to 140 Tbit/s and a capacity-distance product exceeding 1 Exabit/s·km was obtained in 7 cores \times 201 λ \times 100 Gbit/s transmission over 7326 km. These results indicate that the MCF transmission will be one of promising candidates for future ultra-high capacity optical communication systems.

©2014 Optical Society of America

OCIS codes: (060.4230) Multiplexing; (060.2330) Fiber optics communications.

References and links

1. H. Takahashi, T. Tsuritani, E. L. T. de Gabory, T. Ito, W. R. Peng, K. Igarashi, K. Takeshima, Y. Kawaguchi, I. Morita, Y. Tsuchida, Y. Mimura, K. Maeda, T. Saito, K. Watanabe, K. Imamura, R. Sugizaki, and M. Suzuki, "First demonstration of MC-EDFA-repeated SDM transmission of 40 x 128-Gbit/s PDM-QPSK signals per core over 6,160-km 7-core MCF," ECOC2012, Th.3.C.3 (2012).
2. K. Igarashi, K. Takeshima, T. Tsuritani, H. Takahashi, S. Sumita, I. Morita, Y. Tsuchida, M. Tadakuma, K. Maeda, T. Saito, K. Watanabe, K. Imamura, R. Sugizaki, and M. Suzuki, "110.9-Tbit/s SDM transmission over 6,370 km using a full C-band seven-core EDFA," Opt. Express **21**(15), 18053–18060 (2013).
3. K. Igarashi, T. Tsuritani, I. Morita, Y. Tsuchida, K. Maeda, M. Tadakuma, T. Saito, K. Watanabe, K. Imamura, R. Sugizaki, and M. Suzuki, "1.03-Exabit/s·km Super-Nyquist-WDM transmission over 7,326-km seven-core fiber," ECOC2013, PD3, E 3 (2013).
4. J. Sakaguchi, B. J. Puttnam, W. Klaus, Y. Awaji, N. Wada, A. Kanno, T. Kawanishi, K. Imamura, H. Inaba, K. Mukasa, R. Sugizaki, T. Kobayashi, and M. Watanabe, "19-core fiber transmission of 19x100x172-Gbit/s SDM-WDM-PDM-QPSK signals at 305Tb/s," OFC2012, PDP5C.1 (2012).
5. H. Takara, A. Sano, T. Kobayashi, H. Kubota, H. Kawakami, A. Matsuura, Y. Miyamoto, Y. Abe, H. Ono, K. Shikama, Y. Goto, K. Tsujikawa, Y. Sasaki, I. Ishida, K. Takenaga, S. Matsuo, K. Saitoh, M. Koshiba, and T. Morioka, "1.01-Pb/s (12 SDM/222 WDM/456 Gb/s) crosstalk-managed transmission with 91.4-b/s/Hz aggregate spectral efficiency," ECOC2012, Th.3.C.1 (2012).
6. S. Chandrasekhar, A. Gnauck, X. Liu, P. Winzer, Y. Pan, E. C. Burrows, B. Zhu, T. Taunay, M. Fishteyn, M. Yan, J. M. Fini, E. Monberg, and F. Dimarcello, "WDM/SDM transmission of 10 x 128-Gb/s PDM-QPSK over 2688-km 7-Core fiber with a per-fiber net aggregate spectral-efficiency distance product of 40,320 km.b/s/Hz," ECOC2011, Th.13.C.4 (2011).
7. T. Kobayashi, H. Takara, A. Sano, T. Mizuno, H. Kawakami, Y. Miyamoto, K. Hiraga, Y. Abe, H. Ono, M. Wada, Y. Sasaki, I. Ishida, K. Takenaga, S. Matsuo, K. Saitoh, M. Yamada, H. Masuda, and T. Morioka, "2 x 344 Tb/s propagation-direction interleaved transmission over 1500-km MCF enhanced by multicarrier full electric-field digital back-propagation," ECOC2013, PD3, E 4 (2013).
8. V.A.J.M. Sleiffer, Y. Jung, V. Veljanovski, R.G.H. van Uden, M. Kuschnerov, Q. Kang, L. Grüner-Nielsen, Y. Sun, D.J. Richardson, S. Alam, F. Poletti, J.K. Sahu, A. Dhar, H. Chen, B. Inan, A.M.J. Koonen, B. Corbett, R. Winfield, A.D. Ellis and H. de Waardt, "73.7 Tb/s (96X3x256-Gb/s) mode-division-multiplexed DP-16QAM transmission with inline MM-EDFA," ECOC2012, Th.3.C.4 (2012).
9. R. Ryf, S. Randel, N. K. Fontaine, M. Montoliu, E. Burrows, S. Corteselli, S. Chandrasekhar, A. H. Gnauck, C. Xie, R.-J. Essiambre, P. J. Winzer, R. Delbue, P. Pupalaiakis, A. Sureka, Y. Sun, L. Grüner-Nielsen, R. V. Jensen and R. Lingle, Jr., "32-bit/s/Hz spectral efficiency WDM transmission over 177-km few-mode fiber," OFC2013, PDP5A.1 (2013).

10. S. Randel, R. Ryf, A. H. Gnauck, M. A. Mestre, C. Schmidt, R.-J. Essiambre, P. J. Winzer, R. Delbue, P. Pupalaiakis, A. Sureka, Y. Sun, X. Jiang and R. Lingle, Jr., "Mode-multiplexed 6×20 -Gb/s QPSK transmission over 1200-km DGD-compensated few-mode fiber," OFC/NFOEC2012, PDP5C.5 (2012).
11. E. Ip, M.-J. Li, K. Bennett, Y.-K. Huang, A. Tanaka, A. Korolev, K. Koreshkov, W. Wood, E. Mateo, J. Hu and Y. Yano, "146 λ x 6 x 19-Gbaud wavelength- and mode-division multiplexed transmission over 10 x 50-km spans of few-mode fiber with gain-equalized few-mode EDFA," OFC2013, PDP5A.2 (2013).
12. J.-X. Cai, Y. Sun, H. G. Batshon, M. Mazurczyk, H. Zhang, D. G. Foursa, and A. N. Pilipetskii, "54 Tb/s transmission over 9,150 km with optimized hybrid Raman-EDFA amplification and coded modulation," ECOC2014, PD.3.3 (2014).
13. M. Izutsu, S. Shikama, and T. Sueta, "Integrated optical SSB modulator/frequency shifter," IEEE J. Quantum Electron. **17**(11), 2225–2227 (1981).
14. K. Takenaga, Y. Arakawa, S. Tanigawa, N. Guan, S. Matsuo, K. Saito, and M. Koshihara, "Reduction of crosstalk by trench-assisted multi-core fiber," OFC2011, OWJ4 (2011).
15. D. Chang, F. Yu, Z. Xiao, N. Stojanovic, F. N. Hauske, Y. Cai, C. Xie, L. Li, X. Xu, and Q. Xiong, "LDPC convolutional codes using layered decoding algorithm for high speed coherent optical transmission," OFC 2012, OW1H.4 (2012).
16. J. Li, E. Tipsuwannakul, T. Eriksson, M. Karlsson, and P. A. Andrekson, "Approaching Nyquist limit in WDM systems by low-complexity receiver-side duobinary shaping," J. Lightwave Technol. **30**(11), 1664–1676 (2012).
17. K. Saitoh, M. Koshihara, K. Takenaga, and S. Matsuo, "Homogeneous and heterogeneous multi-core fibers," IEEE Photonics Society Summer Topical Meeting 2012, TuC4.4 (2012).
18. T. Mizuno, T. Kobayashi, H. Takara, A. Sano, H. Kawakami, T. Nakagawa, Y. Miyamoto, Y. Abe, T. Goh, M. Oguma, T. Sakamoto, Y. Sasaki, I. Ishida, K. Takenaga, S. Matsuo, K. Saitoh and T. Morioka, "12-core x 3-mode dense space division multiplexed transmission over 40 km employing multi-carrier signals with parallel MIMO equalization," OFC 2014, Th5B.2 (2014).
19. K. S. Abedin, T. F. Taunay, M. Fishteyn, D. J. DiGiovanni, V. R. Supradeepa, J. M. Fini, M. F. Yan, B. Zhu, E. M. Monberg, and F. V. Dimarcello, "Cladding-pumped erbium-doped multicore fiber amplifier," Opt. Express **20**(18), 20191–20200 (2012).
20. K. S. Abedin, J. M. Fini, T. F. Thierry, B. Zhu, M. F. Yan, L. Bansal, F. V. Dimarcello, E. M. Monberg, D. J. DiGiovanni, F. V. Dimarcello, "Seven-core erbium-doped double-clad fiber amplifier pumped simultaneously by side-coupled multimode fiber," Opt. Lett. **39**(4), 993–996 (2014).
21. Y. Tsuchida, M. Tadakuma, and R. Sugizaki, "Multicore EDFA for Space Division Multiplexing by Utilizing Cladding-pumped Technology," OFC2014, Tu2D.1 (2014)

1. Introduction

The demand for higher-capacity optical fiber transmissions is continuously growing. The maximum capacity of a conventional single-mode single-core fiber (SM-SCF), however, will be saturated at around 100 Tbit/s due to the physical limits. As a new technology to break the limits, space-division-multiplexing (SDM) with multi-core fiber (MCF) [1–7] or multi-mode fiber (MMF) [8–11] is intensely studied recently.

Figure 1 shows the reported results of high capacity optical fiber transmission experiments. As shown in Fig. 1, the fiber capacity of the conventional SM-SCF is limited to around 100 Tbit/s. By introducing MCF, the fiber capacity is drastically increased and the highest fiber capacity of 1 Pbit/s has been achieved recently [5].

For long-haul transmission, the highest capacity-distance product (CDP) achieved with SM-SCF is 534 Pbit/s·km, which was reported in 52.2 Tbit/s transmission over 10230 km [12]. With MMF, the longest transmission distance is limited to 1200 km [10] and 500 km [11] in single-channel (3 spacial modes x 40 Gbit/s Dual Polarization (DP)-QPSK) and WDM (3 spacial modes x 146 λ x 76 Gbit/s DP-QPSK) transmission experiments, respectively, and the highest CDP with MMF is 13.9 Pbit/s·km. On the other hand, much longer transmission has been achieved with uncoupled MCF. With 12-core MCF, 688 Tbit/s (12 cores x 748 λ x 77 Gbit/s DP-16QAM) transmission over 1500 km was achieved with a propagation-direction interleaved configuration to suppress the crosstalk between adjacent cores [7]. In this transmission experiment, the CDP of 1.03 Ebit/s·km was obtained.

Trans-oceanic class transmission was achieved by employing 7-core MCF with suppressed inter-core crosstalk [1–3]. The first demonstration of trans-oceanic class transmission with MCF is 28.8 Tbit/s (7 cores x 40 λ x 103 Gbit/s DP-QPSK) transmission over 6160 km [1]. Then the fiber capacity and transmission distance was improved by introducing more spectral efficient modulation format and expanding the gain bandwidth of multi-core EDFA (MC-EDFA) in 7 cores x 264 λ x 72 Gbit/s quasi-Nyquist-WDM DP-QPSK transmission experiment over 6370 km [2]. Recently 140 Tbit/s (7 cores x 201 λ x 100 Gbit/s

duobinary-pulse-shaped DP-QPSK) transmission over 7326 km has been achieved [3]. The obtained CDP in this experiment has also exceeded 1 Ebit/s·km. In this paper, we review these trans-oceanic class transmission experiments with uncoupled MCF.

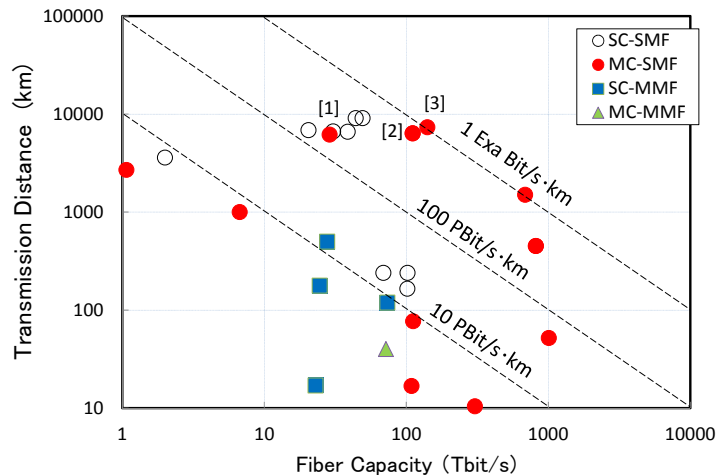

Fig. 1. Recent reports on high capacity transmission.

2. 7 cores x 40 λ x 128 Gbit/s transmission experiment over 6160 km

The first trans-oceanic class transmission with MCF was demonstration in 28.8 Tbit/s (7 cores x 40λ x 103 Gbit/s DP-QPSK) transmission experiment over 6160 km [1]. In this experiment, the spectral efficiency in each core was 2.1 bit/s/Hz and a CDP of 177 Pbit/s·km was achieved.

Figure 2 shows the experimental setup [1]. The transmission experiment was conducted with a 55 km span of 7-core MCF. The cross-section and the main parameters of the MCF at 1550 nm are shown in Fig. 3 and Table 1. MCF is classified in two groups, uncoupled or coupled MCF. In this experiment, uncoupled MCF was used, since high capacity transmission can be achieved by using each core as an independent SDM channel. In long-haul transmission with uncoupled MCF, the most critical parameter of MCF is inter-core crosstalk, since the impact of the inter-core crosstalk is accumulated with a transmission distance. We used MCF with a hexagonal close-packed structure as the core allocation and the inter-core crosstalk of less than -50 dB between two cores after 55 km transmission.

To compensate for the loss of MCF span, MC-EDFAs with Er-doped 7-core MCF were used. The configuration and gain and noise characteristics of the MC-EDFA are shown in Fig. 4 and Fig. 5. In long-haul transmission with MC-EDFA, inter-core crosstalk in MC-EDFA should be also taken into account. In the fabricated 7-core EDFA, the total crosstalk at the center core from six outer cores was as small as -46.5 dB.

A fiber based fan-in/fan-out (FI/FO) modules were used to connect MCF and MC-EDFA. The all of 7 cores were connected sequentially with a core-to-core rotation approach which can average the performance among the cores [6]. To flatten the amplifier gain in the signal wavelength, gain-flattening filters (GFFs) were inserted between the cores and a single-core EDFA was inserted between core 4 and core 5 to compensate for the excess loss of the GFF. A recirculating loop experiment was conducted with the connected 7 spans to evaluate long-haul transmission performance.

In the transmitter, 40 channel signals ranging from 1550.116 nm to 1565.905 nm at 50 GHz spacing were generated. As light sources, external cavity lasers (ECLs) with linewidth of around 100 kHz and DFB-LDs were used. DFB-LDs were replaced by ECLs when the corresponding channel was measured. The even and odd channels were combined with a

100/50 GHz wavelength interleaver (IL) after separately modulated by optical IQ-modulators (IQMs) with QPSK at 32 Gbaud. Then the combined signals were fed into a polarization multiplexing emulator (PME). The nominal data-rate after polarization multiplexing was 128 Gbit/s, which assumed 20% overhead for soft-decision forward-error-correction (SD-FEC) with OTU4 framing over 103.125 Gbit/s Ethernet payload.

At the receiver, the measured channel was selected with optical band-pass filters and received with four balanced photo-diodes (PDs) after the polarization-diversity 90 degree hybrid. The electrical output signals from balanced PDs were digitized by the analog-digital converters (ADC) in a real-time oscilloscope at a sampling-rate of 50 Gsample/s. Then the signals were demodulated by offline digital signal processing (DSP) as follows: The received signals were re-sampled to two sample/symbol. After dispersion compensation in the frequency domain, polarization demultiplexing and signal equalization were performed with half-symbol-spaced FIR filters with 31 taps. In a back-to-back configuration, the required optical signal-to-noise ratio (OSNR) for BER of 1.0×10^{-2} was 13.0 dB with 0.1 nm noise bandwidth.

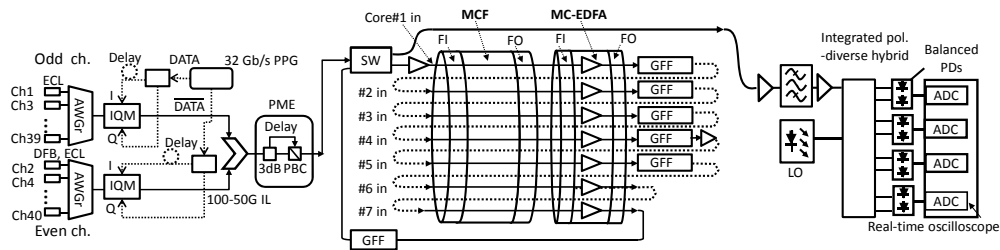

Fig. 2. Experimental setup for 7 cores x 40λ x 128 Gbit/s transmission.

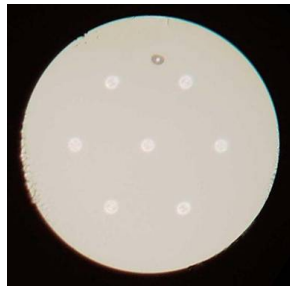

Fig. 3. Cross section of 7-core MCF.

Table 1. Main Parameters of MCF.

# of cores	7
Cladding diameter	200 μm
Core pitch	56 μm
Effective area (A _{eff})	99 μm ²
Attenuation loss	0.188-0.200 dB/km
Chromatic dispersion	18.4-18.7 ps/nm/km
Span length	55 km
Total span loss incl. Fan-in/Fan-out	11.4-12.3 dB

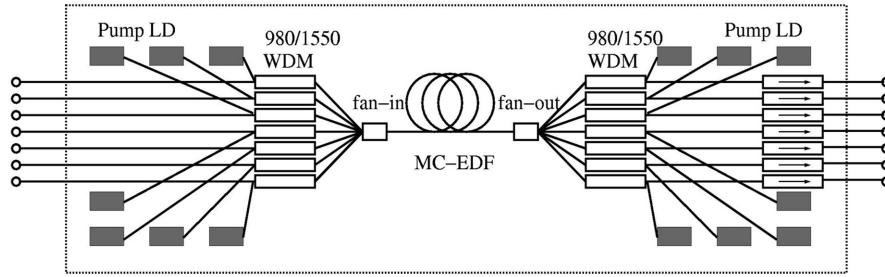

Fig. 4. Configuration of 7-core MC-EDFA.

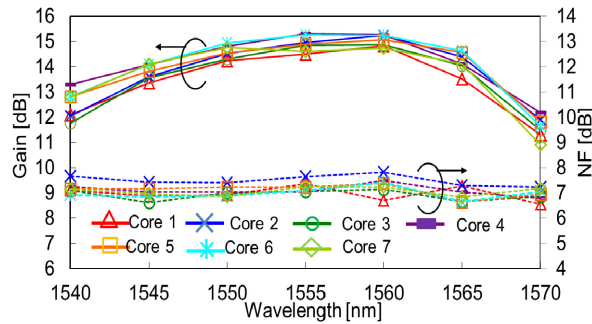

Fig. 5. Gain and noise characteristics of MC-EDFA.

Figure 6 shows the experimental result in 7 core x 40λ x 128 Gbit/s transmission over 6160 km. The transmission performance of each channel was averaged over 7 cores. The insets show the constellation diagram for three channels and optical spectrum after transmission. The averaged OSNR after 6160 km transmission was 15.6 dB with 0.1 nm resolution bandwidth. The worst Q-factor was 7.4 dB for all channels, which had 1 dB margin from 6.4 dB FEC limit of the commercially available SD-FEC with a 20% overhead.

Figure 7 shows the Q-factor and OSNR of around center channel at 1558.17 nm as a function of transmission distance. The Q-penalty caused by the nonlinear effect and inter-core crosstalk after 6160 km transmission is estimated to about 1 dB by referring to the averaged OSNR. The accumulated inter-core crosstalk after 6160 km transmission is calculated to -24.8 dB with the core-to-core rotation approach. Without the core-to-core rotation approach, the accumulated crosstalk would increase to -22.5 dB at the center core. The impact of the accumulated crosstalk depends on OSNR. After 6160 km transmission, the average OSNR is 15.6 dB, which means that the impact of the accumulated amplified spontaneous emission (ASE) noise is much larger. The estimated Q-factor degradation by the increase of crosstalk from -24.8 dB to -22.5 dB is less than 0.2 dB at 15.6 dB of OSNR, which indicates that a similar transmission distance can be expected even without the core-to-core rotation approach.

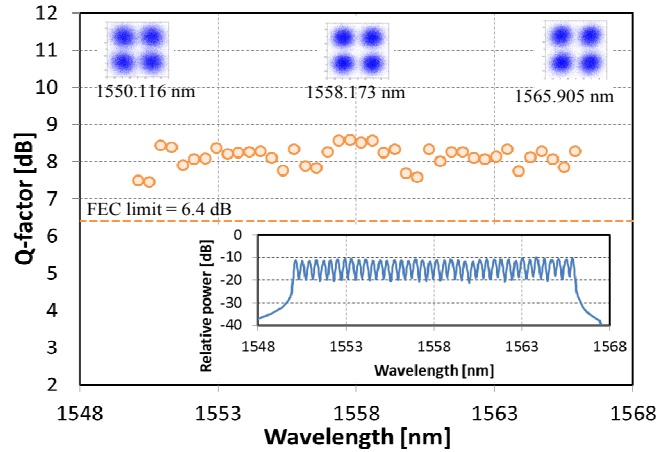

Fig. 6. Transmission performance after 6160 km transmission.

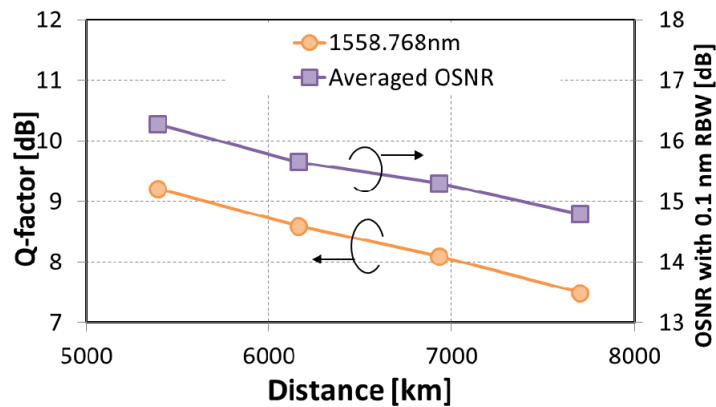

Fig. 7. Transmission distance dependency.

3. 7 cores x 264 λ x 72 Gbit/s transmission experiment over 6370 km

The capacity of trans-oceanic class transmission with MCF was expanded to 110.9 Tbit/s in 7 cores x 264 λ x 72 Gbit/s DP-QPSK transmission experiment over 6370 km [2]. In this experiment, the higher spectral efficiency of 3.2 bit/s/Hz was achieved with quasi-Nyquist – pulse shaping QPSK signals. The gain bandwidth of MC-EDFA was also expanded to full C-band and a CDP of 706 Pbit/s· km was achieved.

Figure 8 shows the experimental setup. Since the number of WDM channels increased to 264, a transmitter setup with a three-rail configuration was used. The two rails generated eight WDM signals for even and odd channels each. The third rail generated 264 WDM channels from 132 lasers at a 37.5 GHz frequency grid. After modulating 132 CW tones with an IQM so that the lower-side-band components were suppressed [13], 264 CW tones with 18.75 GHz spacing were obtained and data-modulated with another IQM. In the experiment, 16 consecutive channels on the third rail were disabled and the 16 channels from the even and odd channel rails were tuned to the corresponding frequencies. Three IQMs used for the QPSK modulation were driven by 18 Gbaud electrical signals with rectangular-shaped spectra generated by an arbitrary waveform generator with a 24 Gsample/s digital-to-analog converter (DAC) after digital signal processing. The signal spectrum of DP-QPSK signal with and without adjacent WDM channels are shown in Fig. 9. Due to the limitation of the bandwidth of DAC, the baud rate was decreased from the previous experiment described in

Section 2. The electrical signal was filtered by a Nyquist filter with a roll-off factor of less of than 0.01. In this condition, the required OSNR for BER of 1.0×10^{-2} was 10.1 dB with 0.1 nm noise bandwidth in a back-to-back configuration.

For MCF, we adopted a trench index core profile [14] in order to obtain a large effective area (A_{eff}) while maintaining low crosstalk. The fiber cross section and main parameters of the modified MCF at 1550 nm are shown in Fig. 10 and Table 2. The measured A_{eff} of all cores at a wavelength of 1550 nm were expanded to $117.5 \sim 125.2 \mu\text{m}^2$. The span length of MCF was slightly shortened to 45.5 km to reduce the span loss and we obtained the span loss including the loss of FI/FO modules of a range of 9.9 to 10.5 dB. The measured crosstalk at the center core from six outer cores in the span was also suppressed to less than -52 dB. A two-stage configuration as shown in Fig. 11 was adopted for MC-EDFA for higher output power and wider gain bandwidth. At the first stage, each core of the MC-EDFA was forward-pumped by a 980 nm laser diode (LD). The second stage was pumped with a bi-directional configuration with two 980 nm LDs. In order to flatten the gain over the full C-band, GFFs based on dielectric multilayer films were inserted between the first and the second stages. Figure 12 shows the gain and noise characteristics measured with 22 WDM signals with a signal power of -8.5 dBm/ch. With the two-stage MC-EDFA, a gain of larger than 13 dB and a noise figure (NF) of lower than 5.5 dB in the 5 THz bandwidth were obtained.

The transmission performance was evaluated with a specially configured seven-fold recirculating loop consisting of a span of 45.5-km seven-core fiber, a seven-core EDFA, and external GFFs. Since the fabricated GFFs inserted in the MC-EDFA were not optimized and the gain shape was not fully flattened as shown in Fig. 12, additional GFFs were inserted after MC-EDFA. The seven loops with different launch cores were synchronously operated as reported in Ref. 6.

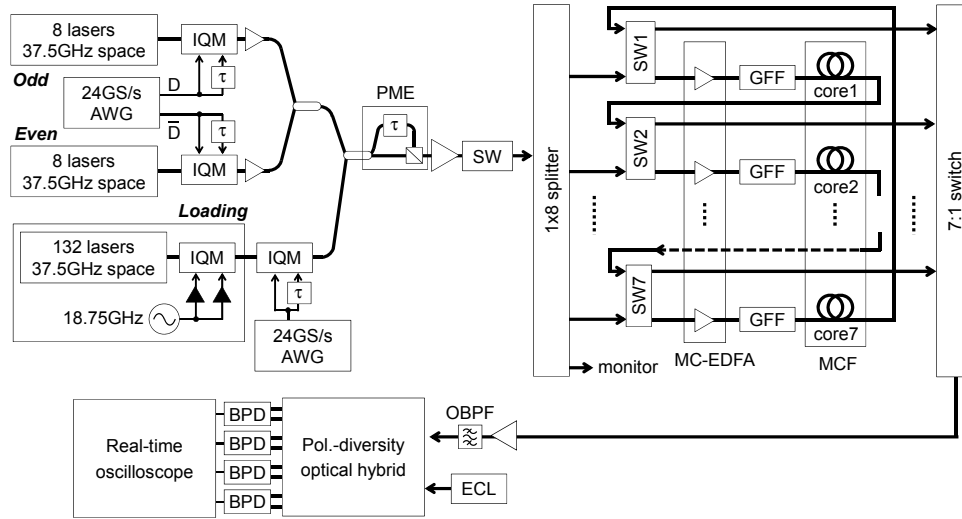

Fig. 8. Experimental setup for 7 cores x 264λ x 72 Gbit/s transmission experiment.

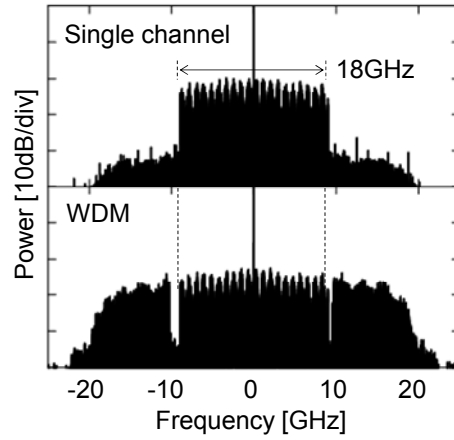

Fig. 9. Signal spectrum of quasi-Nyquist filtered DQ-QPSK signal.

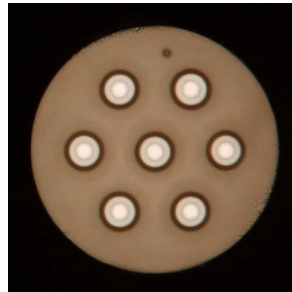

Fig. 10. Cross-section of 7core MCF with a trench index core profile.

Table 2. Main Parameters of modified MCF.

# of cores	7
Cladding diameter	196 μm
Core pitch	56 μm
Effective area (A_{eff})	121 μm^2
Attenuation loss	0.196-0.200 dB/km
Chromatic dispersion	18.4-18.7 ps/nm/km
Span length	45.5 km
Total span loss incl. Fan-in/Fan-out	9.9-10.5 dB

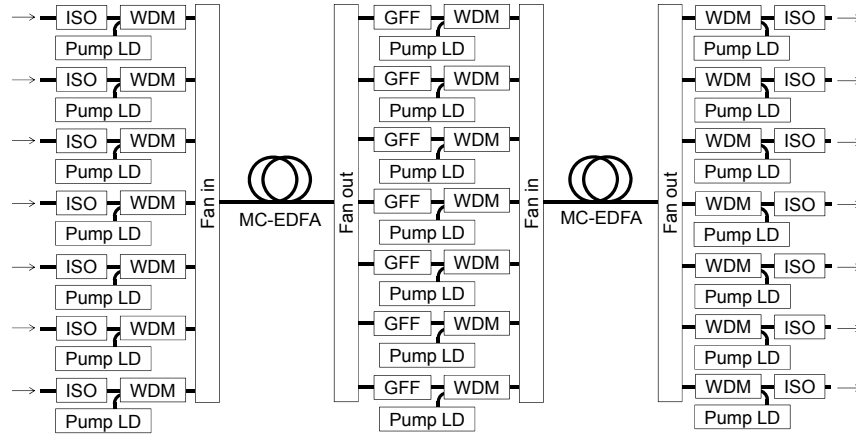

Fig. 11. Configuration of 2-stage MC-EDFA.

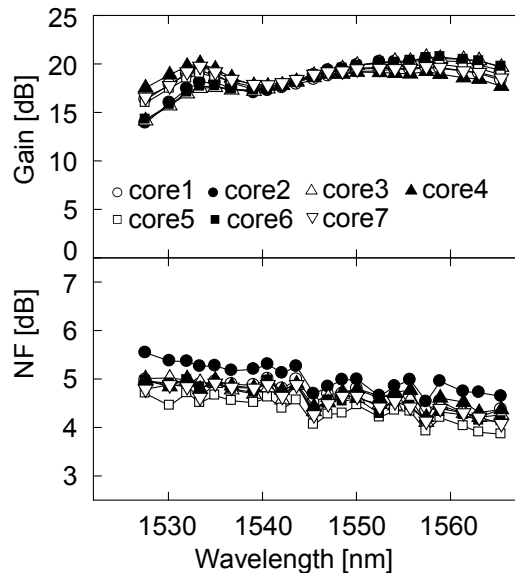

Fig. 12. Gain and noise characteristics of 2-stage MC-EDFA.

We measured Q factors for all 264 WDM channels for seven cores after the 6370 km transmission. Figure 13 shows the measured Q factors for all channels. The Q factors were confirmed to be larger than 6.2 dB, which exceeds 5.7 dB FEC limit of the enhanced SD-FEC with a 20% overhead [15]. The Q-penalty caused by the nonlinear effect and inter-core crosstalk after 6370 km transmission is estimated to be less than 2 dB by referring to the back-to-back performance. The penalty is well suppressed by using MCF with larger A_{eff} and lower inter-core crosstalk even with the higher spectral efficiency compared with the previous experiment described in Section 2.

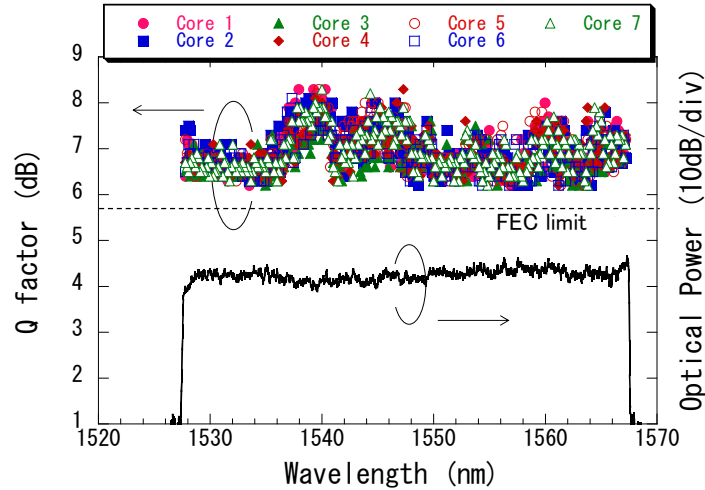

Fig. 13. Transmission performance and optical spectrum after 6370 km transmission.

4. 7 cores x 201 λ x 120 Gbit/s transmission experiment over 7326km

The capacity of trans-oceanic class transmission with MCF was further expanded to 140.7 Tbit/s [3] by introducing Super-Nyquist WDM transmission technique [16] where the channel spacing between WDM channels is set to be smaller than the signal baud rate. In this experiment the spectral efficiency was increased to 4.0 bit/s/Hz and a CDP exceed 1 Exabit/s \cdot km was successfully achieved.

As a Super-Nyquist WDM transmission technique, duobinary-pulse shaping for band limitation was introduced in this experiment. Since the duobinary-pulse shaping degrades the receiver sensitivity, maximum likelihood sequence estimation (MLSE) was also introduced in the receiver to suppress the impact of inter-symbol interference (ISI) caused by the severe band limitation below the baud rate. QPSK signal with duobinary-pulse shaping has nine kinds of symbols in the IQ map as shown in Fig. 14(a). In the trellis diagram, there are two states and four paths for each I or Q component as shown in Fig. 14(b). With MLSE, the most probable path is selected based on the values of the metrics calculated by decision errors.

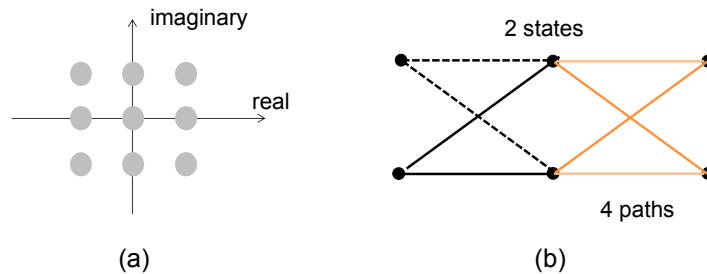

Fig. 14. (a) IQ maps and (b) trellis diagrams of QPSK signal with duobinary-pulse shaping.

Figure 15 shows optical spectra of 30 Gbaud Nyquist-pulse-shaped and duobinary-pulse-shaped DP-QPSK signals with 25 GHz channel spacing. With Nyquist-pulse-shaped WDM signal, a significant spectral overlapping is observed. Duobinary-pulse shaping can suppress the spectral overlapping sufficiently even with the channel spacing of smaller than the signal baud rate. Figure 16 shows the back-to-back performance of 30 Gbaud Nyquist-pulse-shaped and duobinary-pulse-shaped DP-QPSK signals. For duobinary-pulse-shaped signal, MLSE was used at the receiver. In Fig. 16, the performance in single-channel (SC) and WDM transmission with 25 GHz channel spacing are shown. The performance of Nyquist-pulse

shaped signal is significantly degraded by adding neighboring channels. A combination of duobinary-pulse shaping and MLSE can sufficiently suppress the impact of crosstalk from adjacent channels and the penalty from the single-channel transmission can be suppressed to below 2 dB even with 25 GHz channel spacing. In this condition, the required OSNR for BER of 1.0×10^{-2} was 13.1 dB with 0.1 nm noise bandwidth.

With this Super-Nyquist WDM transmission technique, high capacity long-haul transmission experiment was conducted. The configuration of transmitter and receiver was similar as the previous experiment described in Section 3. The number of WDM channels and the signal baud rate were increased to 201 and 30 Gbaud, respectively. 30 Gbaud duobinary-pulse-shaped QPSK signal was generated with an arbitrary waveform generator with a 50 Gsample/s DAC. In the receiver DSP, MLSE was added. We used the identical transmission line as the previous experiment. The fiber launch power was increased from 17 dBm to 21 dBm corresponding to the increase of the number of channels and the signal bit rate.

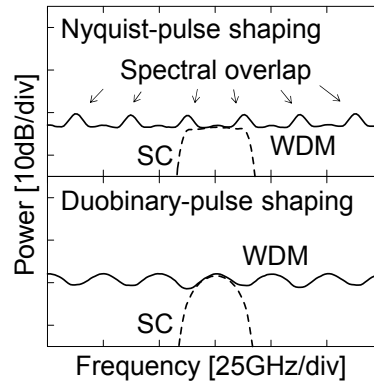

Fig. 15. Optical spectra of 30 Gbaud Nyquist-pulse shaped and duobinary-pulse shaped QPSK signals with 25 GHz channel spacing.

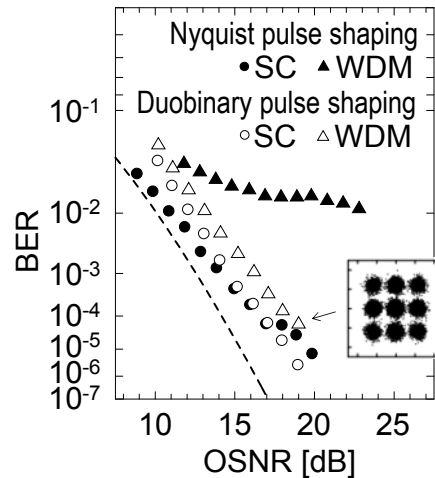

Fig. 16. Back-to-back performance of 30 Gbaud Nyquist-pulse shaped and duobinary-pulse shaped QPSK signals.

The measured Q factors for all channels after 7326 km transmission are shown in Fig. 17. For each channel, seven measurements were conducted in seven types of configuration of recirculating loops with a different starting core. A typical constellation diagram of the received signal before MLSE is also shown in Fig. 17. The Q factors of all the cases were

confirmed to be larger than 6.0 dB, which exceeds the FEC limit of 5.7 dB [15]. The Q-penalty caused by the nonlinear effect and inter-core crosstalk after 7326 km transmission is estimated to be around 2 dB.

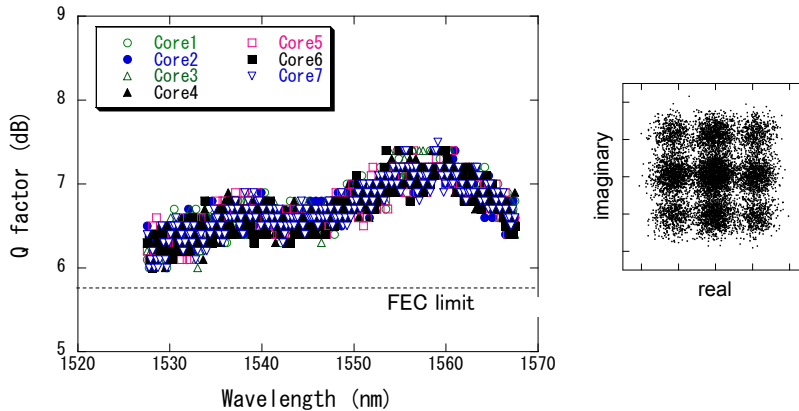

Fig. 17. Measured Q-factors for all channels and a typical constellation diagram after 7326 km transmission.

5. Further increase of capacity in long-haul transmission with MCF

In order to increase the capacity of MCF transmission system furthermore, increasing the number of core is an attractive approach. To date, the number of core is limited to seven in trans-oceanic class transmission experiments. This is because the impact of inter-core crosstalk accumulates with a transmission distance and the larger number of core usually leads to larger inter-core crosstalk due to some limitation of the cladding diameter of MCF considering a failure probability. To solve this problem, some new technologies to suppress the inter-core crosstalk in MCF must be introduced. The use of heterogeneous MCF which has different kinds of core in a fiber [17] is one of the possible approaches. The heterogeneous MCF consists of several kinds of core and propagation constants of neighboring cores are set to be different. This can effectively suppress the power conversion efficiency between neighboring cores. The transmission experiment using 40 km heterogeneous MCF with 12 cores was reported in [18]. It is expected to verify the effectiveness of heterogeneous MCF in a transmission experiment with much longer distance.

A main advantage of SDM compared with high capacity systems with multiple fibers is higher space utilization efficiency. In trans-oceanic submarine cable systems, the space limitation is more severe in optical amplifier repeaters rather than the optical fiber cable. Therefore it is desired to reduce the size of optical amplifier by integrating optical components which should increase lineally with the number of fibers in conventional systems. A reduction of power consumption in optical amplifier repeaters fed from landing stations is another issue in high capacity submarine cable systems. To date, there are several reports on MC-EDFA in which all cores are simultaneously pumped using a single high pump laser [19–21]. To apply high capacity MCF transmission technologies to optical submarine cable systems, further advances in these technologies for optical amplifier integration is expected.

6. Conclusion

Trans-oceanic class transmission experiments with uncoupled MCF are reviewed. Ultra-long-haul transmission was successfully achieved by using 7-core MCF with suppressed inter-core cross talk. The use of a combination of MCF and high spectral efficiency modulation format could increase the fiber capacity drastically and a CDP exceeding 1 Ebit/s·km was obtained in 7 cores \times 201 λ \times 100 Gbit/s (140 Tbit/s) transmission over 7326 km. These results indicate

that the MCF transmission will be one of promising candidates for future ultra-high capacity optical communication systems.

Acknowledgments

The authors would like to express their thanks to colleagues in KDDI R&D Labs, Furukawa Electric and NEC for their support for the experiments. The authors also thank Dr. Y. Nakajima of KDDI R&D Labs for his continued support. This work was partly supported by “R&D of Innovative Optical Communication Infrastructure”, the Commissioned Research of National Institute of Information and Communications Technology (NICT), Japan.